

FLIP TOP 24/410 CV

VR 040

CARATTERISTICHE TECNICHE Technical data sheet

Tipo di capsula Closure type	Monopezzo One-piece cap	
Applicazione Application	Cosmetica/detergenza/alimentare Cosmetics/detergents/food	
Imboccatura Neck finish	24/410	
Apertura Opening	Flip top	
Materiale Material	PP	
Peso Weight	gr	4,3 +/- 0,2
Opzioni Options	incisione embossed logo tampografia printing	NO NO
Tipo di chiusura Type of closure	A vite Screw on	
Foro erogatore Dispensing hole	diametro	3,3 mm
Tenuta Sealing	Cono interno Inner plug	
Forza di chiusura Recommended closure torque	kg.cm inch.lbs	17 10 +/- 3
Test pressione Sealing test	bar	0,3 (1 min)
Pressione massima Max pressure	bar	1
Forza apertura flip top Flip top opening force	N	10 +/- 3

CARATTERISTICHE DI IMBALLAGGIO E DI SPEDIZIONE Packaging and shipment

Scatola Box	cm	60 x 40 x 31	
	pz	2.500	
Pallet Pallet	cm	80 x 120 x 235	
	pz	60.000	
Camion Truck	pallets	pallets	33
	scatole	boxes	792
	pz	pcs	1.980.000
Container 20' 20' Container	scatole	boxes	295
	pz	pcs	737.500
Container 40' 40' Container	scatole	boxes	600
	pz	pcs	1.500.000
Container 40' HC 40' HC Container	scatole	boxes	690
	pz	pcs	1.725.000

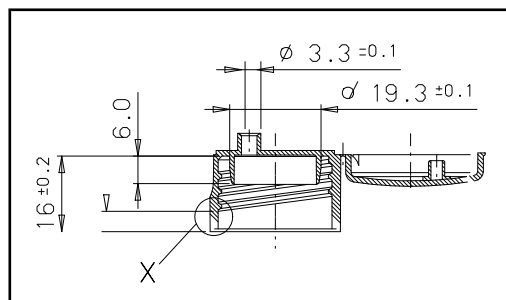

I valori indicati sono da considerarsi orientativi in quanto variabili in base alle caratteristiche dell'impianto e/o della bottiglia e/o delle condizioni specifiche di applicazione e/o condizioni ambientali.

The above information are to be considered as indications as they can vary depending on the plant and/or the bottle and/or the specific condition of application and/or the environment.



Via degli Olmi, 43 - 50041 Calenzano (FI)
055/886611 viroplastic@viroplastic.it
www.viroplastic.it



**COMPANY WITH
QUALITY SYSTEM
CERTIFIED BY DNV GL
= ISO 9001 =**